

# IN-LINE VENTILY SUPER X

## Manuálně a mechanicky ovládaný šoupátkový ventil

3/2, 5/2 a 5/3, G1/8, G1/4



Široký sortiment operátorů  
Vhodné pro vícesměrový průtok a aplikace s duálním napájením  
Vysoká průtočnost  
Lehké a antikorozní materiály

### TECHNICKÉ ÚDAJE

#### Médium:

Stlačený vzduch, filtrovaný, mazaný nebo nemazaný

#### Provozní tlak:

Maximálně 10 bar

#### Teplota prostředí:

Podle elektromagnetického systému 0°C ... +70°C

Kontaktujte naše technické oddělení, pokud chcete používat přístroj pod +2°C

### MATERIÁLY

Tělo: slitina zinku

Uzavírací víko: hliník, slitina zinku nebo silon s skleněným plnivem

Těsnění: nitrilová pryž

## MODELY MECHANICKÝCH VENTILŮ

### 3/2 mechanické ventily

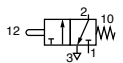
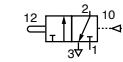
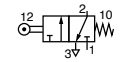
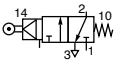
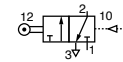
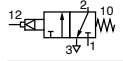
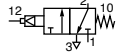

Značka	Ovládání	Velikosti přípojovacího závitu	Průtok (l/min)	MODELY		PŘÍSLUŠENSTVÍ			SERVISNÍ SADA
				Výkres č.	Přímé šroubení	L-šroubení	Tlumič hluku		
	Plunžr /Pružina	G1/8	335	03 0400 02	A, 1	C02250618	C02470618	T40C1800	03 8408 02
	Plunžr /Pružina	G1/4	965	03 0600 02	B, 3	C02250828	C02470828	T40C2800	03 8602 02
	Plunžr /Pilot	G1/8	335	03 0417 02	C, 1	C02250618	C02470618	T40C1800	03 8408 02
	Rolna /Pružina	G1/8	335	03 0402 02	A, 2	C02250618	C02470618	T40C1800	03 8408 02
	Rolna /Pružina	G1/4	965	03 0602 02	B, 6	C02250828	C02470828	T40C2800	03 8602 02
	Páka rolny /Pružina	G1/8	335	03 0411 02	A, 4	C02250618	C02470618	T40C1800	03 8408 02
	Páka rolny /Pružina	G1/4	965	03 0611 02	B, 9	C02250828	C02470828	T40C2800	03 8602 02
	Páka rolny (vysoké namáhání) /Pružina	G1/8	335	03 0293 02	A, 10	C02250618	C02470618	T40C1800	03 8408 02
	Citlivá páka rolny /Pružina	G1/8	335	03 0423 02	A, 5	C02250618	C02470618	T40C1800	-
	Rolna /Pilot	G1/8	335	03 0409 02	C, 2	C02250618	C02470618	T40C1800	03 8408 02
	Rolna /Pilot	G1/4	965	03 0609 02	D, 6	C02250828	C02470828	T40C2800	03 8612 02
	Páka rolny /Pilot	G1/8	335	03 0427 02	C, 4	C02250618	C02470618	T40C1800	03 8408 02
	Páka rolny /Pilot	G1/4	965	03 0624 02	D, 9	C02250828	C02470828	T40C2800	03 8612 02
	Páka rolny /Pilot	G1/4	965	03 0624 02	D, 9	C02250828	C02470828	T40C2800	03 8612 02
	Jednocestné vypnutí /Pružina	G1/8	335	03 0410 02	A, 7	C02250618	C02470618	T40C1800	03 8408 02
	Jednocestné vypnutí (vysoké namáhání) /Pružina	G1/8	335	03 0294 02	A, 11	C02250618	C02470618	T40C1800	03 8408 02
	Anténa /Pružina	G1/8	335	03 0432 02	A, 8	C02250618	C02470618	T40C1800	-

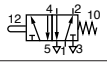
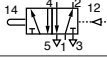
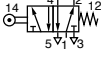
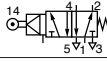
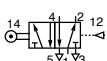
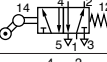
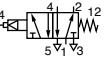
## 5/2 mechanické ventily

Ovládání	Velikost připojova- cího otvoru	Průtok (l/min)	MODELY		Výkres č.	PŘÍSLUŠENSTVÍ			SERVISNÍ SADA
			Přímé šroubení	L- šroubení		Tlumič hluku			
 Plunžr /Pružina Plunžr /Pružina	G1/8	335	<b>X3 0440 02</b>	E, 1	Průměr trubky tučným písmem			03 8408 02	
	G1/4	965	<b>X3 0640 02</b>	F, 3	C02250618	C02470618	T40C1800	03 8602 02	
 Plunžr /Pilot	G1/8	335	<b>X3 0457 02</b>	G, 1	C02250618	C02470618	T40C1800	03 8408 02	
 Rolna /Pružina Rolna /Pružina Páka rolny /Pružina Páka rolny /Pružina Páka rolny (vysoké namáhání) /Pružina	G1/8	335	<b>X3 0442 02</b>	E, 2	C02250618	C02470618	T40C1800	03 8408 02	
	G1/4	965	<b>X3 0642 02</b>	F, 6	C02250828	C02470828	T40C2800	03 8602 02	
	G1/8	335	<b>X3 0451 02</b>	E, 4	C02250618	C02470618	T40C1800	03 8408 02	
	G1/4	965	<b>X3 0651 02</b>	F, 9	C02250828	C02470828	T40C2800	03 8602 02	
	G1/8	335	<b>X3 0393 02</b>	E, 10	C02250618	C02470618	T40C1800	03 8408 02	
 Citlivá páka rolny /Pružina	G1/8	335	<b>X3 0463 02</b>	E, 5	C02250618	C02470618	T40C1800	-	
 Rolna /Pilot Rolna /Pilot Páka rolny /Pilot Páka rolny /Pilot	G1/8	335	<b>X3 0449 02</b>	G, 2	C02250618	C02470618	T40C1800	03 8408 02	
	G1/4	965	<b>X3 0649 02</b>	H, 6	C02250828	C02470828	T40C2800	03 8612 02	
	G1/8	335	<b>X3 0467 02</b>	G, 4	C02250618	C02470618	T40C1800	03 8408 02	
	G1/4	965	<b>X3 0664 02</b>	H, 9	C02250828	C02470828	T40C2800	03 8612 02	
 Jednocestné vypnutí /Pružina Jednocestné vypnutí (vysoké namáhání) /Pružina	G1/8	335	<b>X3 0450 02</b>	E, 7	C02250618	C02470618	T40C1800	03 8408 02	
	G1/8	335	<b>X3 0394 02</b>	E, 11	C02250618	C02470618	T40C1800	03 8408 02	
 Anténa /Pružina	G1/8	335	<b>X3 0472 02</b>	E, 8	C02250618	C02470618	T40C1800	-	

## MANUAL VALVE MODELY

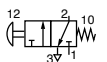
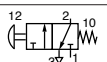
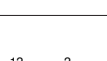
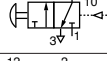
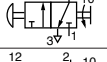
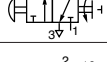
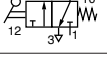
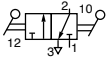
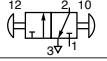
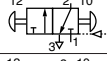
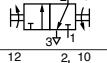
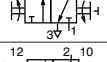

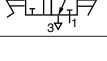



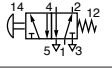
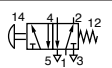
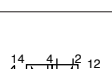
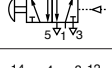
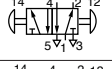
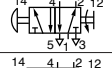
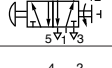

### 3/2 mechanické ventily

Ovládání	Velikost připojova- cího otvoru	Průtok (l/min)	Barva	MODELY		Výkres č.	PŘÍSLUŠENSTVÍ			SERVISNÍ SADA
				Přímé šroubení	L- šroubení		Tlumič hluku			
 Tlačítko/pružina Tlačítko/pružina Tlačítko/pružina	G1/8	335	Černý	<b>03 0404 02</b>	A, 12	C02250618	C02470618	T40C1800	03 8408 02	
	G1/4	965	Černý	<b>03 0604 02</b>	B, 14	C02250828	C02470828	T40C2800	03 8602 02	
	G1/8	335	Zelený	<b>03 0405 02</b>	A, 12	C02250618	C02470618	T40C1800	03 8408 02	
 Tlačítko (hříbek)/pružina Tlačítko (hříbek)/pružina Tlačítko (hříbek)/pružina Tlačítko (krytované)/pružina Tlačítko (krytované)/pružina Tlačítko (krytované)/pružina	G1/8	335	Červený	<b>03 0406 02</b>	A, 12	C02250618	C02470618	T40C1800	03 8408 02	
	G1/8	335	Červený	<b>03 0366 02</b>	A, 15	C02250618	C02470618	T40C1800	03 8408 02	
	G1/8	335	Zelený	<b>03 0367 02</b>	A, 15	C02250618	C02470618	T40C1800	03 8408 02	
	G1/8	335	Černý	<b>03 0368 02</b>	A, 15	C02250618	C02470618	T40C1800	03 8408 02	
	G1/8	335	Černý	<b>03 0414 02</b>	A, 13	C02250618	C02470618	T40C1800	03 8408 02	
 Tlačítko (krytované)/pružina Tlačítko (krytované)/pružina Tlačítko (krytované)/pružina	G1/8	335	Zelený	<b>03 0415 02</b>	A, 13	C02250618	C02470618	T40C1800	03 8408 02	
	G1/8	335	Červený	<b>03 0416 02</b>	A, 13	C02250618	C02470618	T40C1800	03 8408 02	
	G1/8	335	Černý	<b>03 0408 02</b>	C, 12	C02250618	C02470618	T40C1800	03 8408 02	
 Tlačítko/pilot Tlačítko/pilot Tlačítko/pilot	G1/4	965	Černý	<b>03 0608 02</b>	D, 14	C02250828	C02470828	T40C2800	03 8612 02	
	G1/8	335	Zelený	<b>03 0420 02</b>	C, 12	C02250618	C02470618	T40C1800	03 8408 02	
	G1/8	335	Červený	<b>03 0421 02</b>	C, 12	C02250618	C02470618	T40C1800	03 8408 02	
 Nouzové zastavení/šroubovitý kroužek	G1/8	335	Červený	<b>03 0299 02</b>	A, 16	C02250618	C02470618	T40C1800	03 8473 02	
 Tlačítko, hříbek/tlačítko	G1/8	335	Červený	<b>03 0335 02</b>	A, 17	C02250618	C02470618	T40C1800	03 8408 02	
 Páka/pružina Páka/pružina Pákový knoflík/pružina	G1/8	335	Černý	<b>03 0438 02</b>	A, 23	C02250618	C02470618	T40C1800	03 8408 02	
	G1/4	965	Černý	<b>03 0638 02</b>	B, 31	C02250828	C02470828	T40C2800	03 8602 02	
	G1/8	335	Černý	<b>03 0426 02</b>	A, 19	C02250618	C02470618	T40C1800	03 8408 02	
 Přepínač/přepínač Páka/páka Páka/páka	G1/8	335	Černý	<b>03 0403 02</b>	A, 22	C02250618	C02470618	T40C1800	03 8408 02	
	G1/8	335	Černý	<b>03 0437 02</b>	A, 23	C02250618	C02470618	T40C1800	03 8408 02	
	G1/4	965	Černý	<b>03 0637 02</b>	B, 31	C02250828	C02470828	T40C2800	03 8602 02	
 knoflík/knoflík knoflík/knoflík	G1/8	335	Černý	<b>03 0425 02</b>	A, 21	C02250618	C02470618	T40C1800	03 8408 02	
	G1/4	965	Černý	<b>03 0625 02</b>	B, 20	C02250828	C02470828	T40C2800	03 8602 02	
 knoflík/knoflík nebo pilot knoflík/knoflík nebo pilot	G1/8	335	Černý	<b>03 0424 02</b>	D, 21	C02250618	C02470618	T40C1800	03 8408 02	
	G1/4	965	Černý	<b>03 0627 02</b>	D, 20	C02250828	C02470828	T40C2800	03 8612 02	
 Otočný knoflík/otočný knoflík	G1/8	335	Černý	<b>03 0298 02</b>	A, 27	C02250618	C02470618	T40C1800	03 8408 02	
 Tlačítko/tlačítko	G1/8	335	Pochromovaný	<b>03 0418 02 801</b>	A, 28	C02250618	C02470618	T40C1800	03 8408 02	
 Pedál/pružina Pedál/pružina	G1/8	335	Černý	<b>03 0481 02</b>	29	C02250618	C02470618	T40C1800	03 8408 02	
	G1/4	965	Černý	<b>03 0681 02</b>	29	C02250828	C02470828	T40C2800	03 8602 02	
 Pedál/pedál Pedál/pedál	G1/8	335	Černý	<b>03 0483 02</b>	29	C02250618	C02470618	T40C1800	03 8408 02	
	G1/4	965	Černý	<b>03 0683 02</b>	29	C02250828	C02470828	T40C2800	03 8602 02	

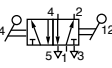
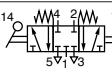
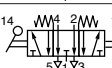
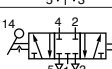
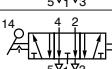
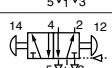
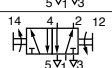
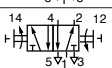
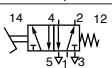
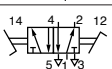
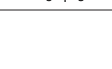
# IN-LINE VENTILY SUPER X Manuálně a mechanicky ovládaný šoupátkový ventil

3/2, 5/2 a 5/3, G1/8, G1/4

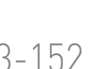
## 5/2 a 5/3 manuální ventily

Ovládání	Střed. pol.	Velikosti přípojovacího závitu	Průtok (l/min)	Barva	MODELY	Výkres č.	PŘÍSLUŠENSTVÍ			SERVISNÍ SADA
							Přímé šroubení	L-šroubení	Tlumič hluku	
Tlačítko/pružina	-	G1/8	335	Černý	<b>X3 0444 02</b>	E, 12	C02250618	C02470618	T40C1800	03 8408 02
Tlačítko/pružina	-	G1/4	965	Černý	<b>X3 0644 02</b>	F, 14	C02250828	C02470828	T40C2800	03 8602 02
Tlačítko/pružina	-	G1/8	335	Zelený	<b>X3 0445 02</b>	E, 12	C02250618	C02470618	T40C1800	03 8408 02
Tlačítko/pružina	-	G1/8	335	Červený	<b>X3 0446 02</b>	E, 12	C02250618	C02470618	T40C1800	03 8408 02
 Tlačítko (hříbek)/pružina	-	G1/8	335	Červený	<b>X3 0386 02</b>	E, 15	C02250618	C02470618	T40C1800	03 8408 02
 Tlačítko (hříbek)/pružina	-	G1/8	335	Zelený	<b>X3 0387 02</b>	E, 15	C02250618	C02470618	T40C1800	03 8408 02
 Tlačítko (hříbek)/pružina	-	G1/8	335	Černý	<b>X3 0388 02</b>	E, 15	C02250618	C02470618	T40C1800	03 8408 02
 Tlačítko (krytované)/pružina	-	G1/8	335	Černý	<b>X3 0454 02</b>	E, 13	C02250618	C02470618	T40C1800	03 8408 02
 Tlačítko (krytované)/pružina	-	G1/8	335	Zelený	<b>X3 0455 02</b>	E, 13	C02250618	C02470618	T40C1800	03 8408 02
 Tlačítko (krytované)/pružina	-	G1/8	335	Červený	<b>X3 0456 02</b>	E, 13	C02250618	C02470618	T40C1800	03 8408 02
Tlačítko/pilot	-	G1/8	335	Černý	<b>X3 0448 02</b>	G, 12	C02250618	C02470618	T40C1800	03 8408 02
Tlačítko/pilot	-	G1/4	965	Černý	<b>X3 0648 02</b>	H, 14	C02250828	C02470828	T40C2800	03 8612 02
Tlačítko/pilot	-	G1/8	335	Zelený	<b>X3 0460 02</b>	G, 12	C02250618	C02470618	T40C1800	03 8408 02
Tlačítko/pilot	-	G1/8	335	Červený	<b>X3 0461 02</b>	G, 12	C02250618	C02470618	T40C1800	03 8408 02
 knoflík, stisknout/knoflík, táhnout	-	G1/8	335	Černý	<b>X3 0465 02</b>	E, 26	C02250618	C02470618	T40C1800	03 8408 02
 knoflík/knoflík	-	G1/4	965	Černý	<b>X3 0665 02</b>	M, 20	C02250828	C02470828	T40C2800	03 8602 02
 Nouzové zastavení/šroubovitý kroužek	-	G1/8	335	Červený	<b>X3 0299 02</b>	E, 16	C02250618	C02470618	T40C1800	03 8473 02
 Palm Tlačítko, push/Tlačítko	-	G1/8	335	Červený	<b>X3 0375 02 801</b>	E, 17	C02250618	C02470618	T40C1800	03 8408 02
 Páka/pružina	-	G1/8	335	Černý	<b>X3 0478 02</b>	E, 22	C02250618	C02470618	T40C1800	03 8408 02
 Páka/pružina	-	G1/4	965	Černý	<b>X3 0678 02</b>	F, 31	C02250828	C02470828	T40C2800	03 8602 02
 Pákový knoflík/pružina	-	G1/8	335	Černý	<b>X3 0466 02</b>	E, 19	C02250618	C02470618	T40C1800	03 8408 02
 Přepínač/přepínač	-	G1/8	335	Černý	<b>X3 0443 02</b>	E, 24	C02250618	C02470618	T40C1800	03 8408 02
 Páka/páka	-	G1/8	335	Černý	<b>X3 0477 02</b>	E, 23	C02250618	C02470618	T40C1800	03 8408 02
 Páka/páka	-	G1/4	965	Černý	<b>X3 0677 02</b>	F, 31	C02250828	C02470828	T40C2800	03 8602 02
 Páka/pružina/páka	APB	G1/8	335	Černý	<b>X3 3438 02</b>	J, 32	C02250618	C02470618	T40C1800	03 8408 02
 Páka/pružina/páka	APB	G1/4	965	Černý	<b>X3 3638 02</b>	J, 32	C02250828	C02470828	T40C2800	03 8602 02
 Páka/pružina/páka	COE	G1/8	335	Černý	<b>X3 3478 02</b>	J, 32	C02250618	C02470618	T40C1800	03 8408 02
 Páka/pružina/páka	COE	G1/4	965	Černý	<b>X3 3678 02</b>	J, 32	C02250828	C02470828	T40C2800	03 8602 02
 Páka/páka/páka	APB	G1/8	335	Černý	<b>X3 3437 02</b>	J, 32	C02250618	C02470618	T40C1800	03 8408 02
 Páka/páka/páka	APB	G1/4	965	Černý	<b>X3 3637 02</b>	J, 32	C02250828	C02470828	T40C2800	03 8602 02
 Páka/páka/páka	COE	G1/8	335	Černý	<b>X3 3477 02</b>	J, 32	C02250618	C02470618	T40C1800	03 8408 02
 Páka/páka/páka	COE	G1/4	965	Černý	<b>X3 3677 02</b>	J, 32	C02250828	C02470828	T40C2800	03 8602 02
knoflík/knoflík nebo pilot	-	G1/8	335	Černý	<b>X3 0464 02</b>	G, 21	C02250618	C02470618	T40C1800	03 8408 02
Otočný knoflík/otočný knoflík	-	G1/8	335	Černý	<b>X3 0298 02</b>	E, 27	C02250618	C02470618	T40C1800	03 8408 02
Tlačítko/tlačítko	-	G1/8	335	Chrome	<b>X3 0458 02 801</b>	E, 28	C02250618	C02470618	T40C1800	03 8408 02
Pedál/pružina	-	G1/8	335	Černý	<b>X3 0482 02</b>	29	C02250618	C02470618	T40C1800	03 8408 02
Pedál/pružina	-	G1/4	965	Černý	<b>X3 0682 02</b>	29	C02250828	C02470828	T40C2800	03 8602 02
Pedál/pedál	-	G1/8	335	Černý	<b>X3 0484 02</b>	29	C02250618	C02470618	T40C1800	03 8408 02
Pedál/pedál	-	G1/4	965	Černý	<b>X3 0684 02</b>	29	C02250828	C02470828	T40C2800	03 8602 02

## ROZMĚRY

G1/8, 3/2 Vratná pružina, základní tělo

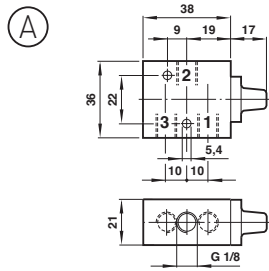

G1/4, 3/2 Vratná pružina, základní tělo

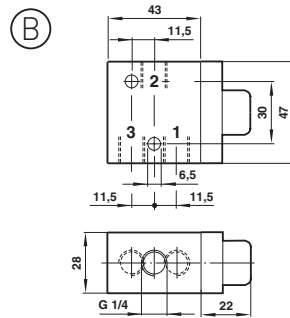

G1/8, 3/2 Vzduchová pružina, základní tělo

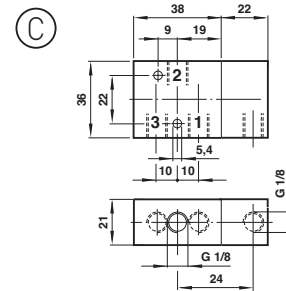

G1/4, 3/2 Vzduchová pružina, základní tělo

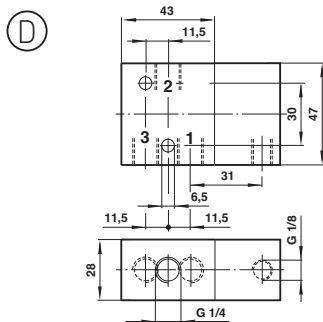

G1/8, 5/2 Vratná pružina, základní tělo

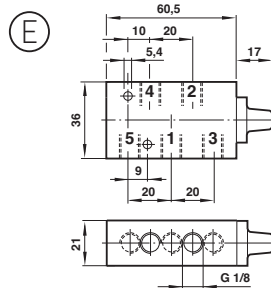

G1/4, 5/2 Vratná pružina, základní tělo

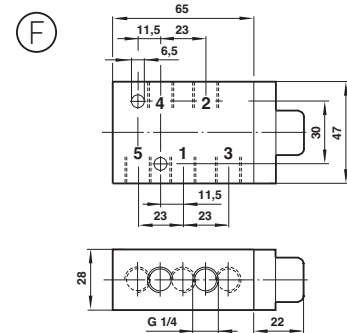

G1/8, 5/2 Vzduchová pružina, základní tělo

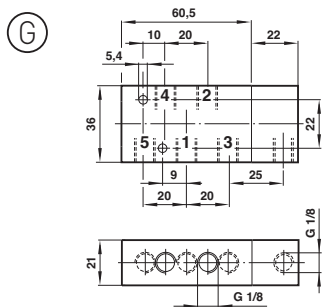

G1/4, 5/2 Vzduchová pružina, základní tělo

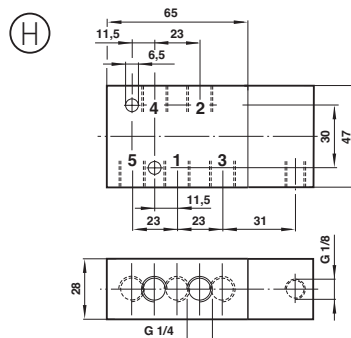

G1/4, 5/3 Vratná pružina, základní tělo

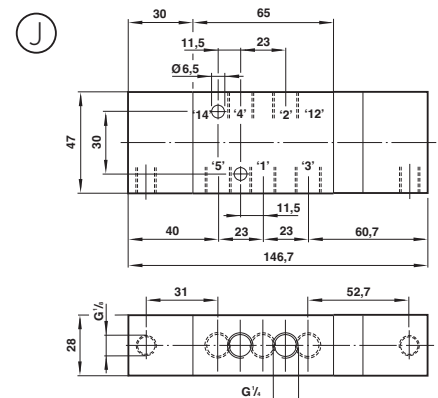

# IN-LINE VENTILY SUPER X Manuálně a mechanicky ovládaný šoupátkový ventil

3/2, 5/2 a 5/3, G1/8, G1/4

## Pohony mechanických ventilů

Plunžr – G1/8 ventily

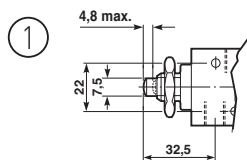

Rolna – G1/8 ventily

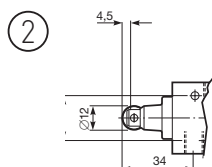

Plunžr – G1/4 ventily

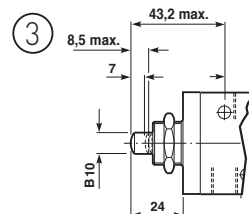

Páka rolny – G1/8 ventily

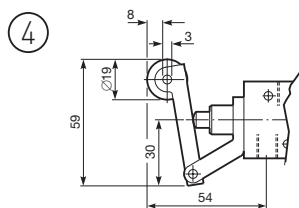

Citlivá páka rolny – G1/8 ventily

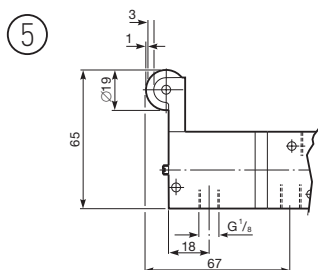

Rolna – G1/4 ventily

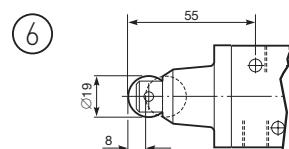

Jednocestné vypnutí – G1/8 ventily

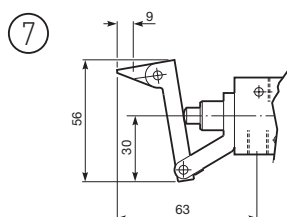

Tykadlo – G1/8 ventily

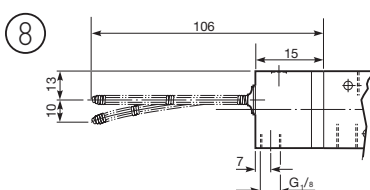

Páka rolny – G1/4 ventily

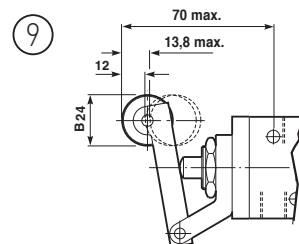

Páka rolny pro vysoké namáhání – G1/8 ventily

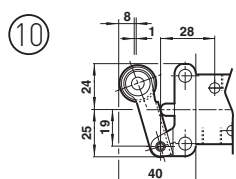

Páka rolny pro vysoké namáhání - jednocestná – G1/8 ventily

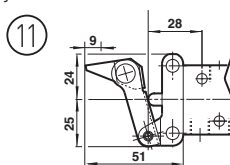

## Ovládací prvky ventilů

Tlačítko – G1/8 ventily

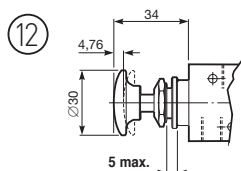

Tlačítko (krytované) – G1/8 ventily

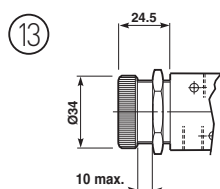

Tlačítko – G1/4 ventily

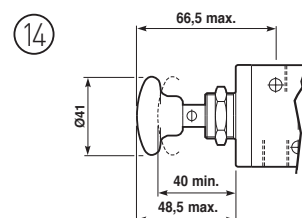

Tlačítko (hříbek) – G1/8 ventily

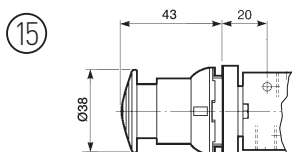

Nouzové zastavení – G1/8 ventily

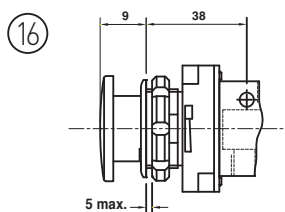

Knoflík/tlačítko – G1/8 ventily

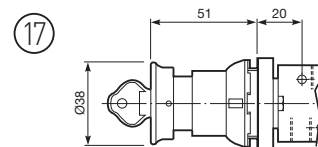

Páka/otočný knoflík – G1/8 ventily

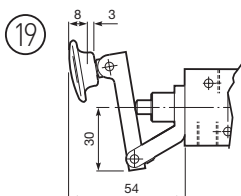

knoflík – G1/4 ventily

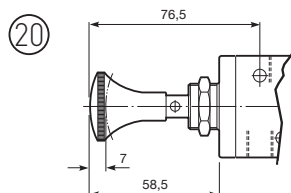

knoflík – G1/8 ventily

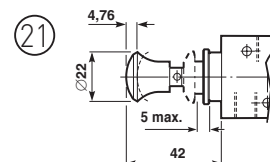

# IN-LINE VENTILY SUPER X Manuálně a mechanicky ovládaný šoupátkový ventil

3/2, 5/2 a 5/3, G1/8, G1/4

Ventil s vratnou pružinou ovládanou pákou – G1/8 ventily

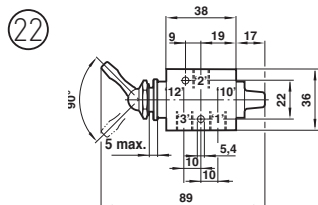

Ventil s vratnou pružinou ovládanou pákou – G1/8 ventily

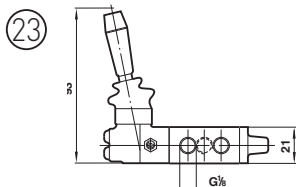

Spínač – G1/8 ventily

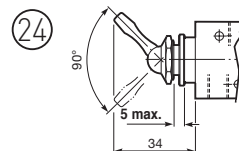

Ventil s vratnou pružinou ovládanou pákou – G1/8 ventily

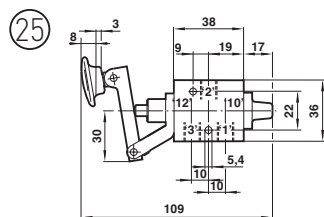

Knoflík stisknout/táhnout – G1/8 ventily

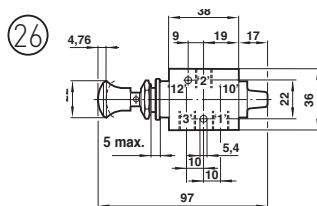

Otočný knoflík – G1/8 ventily

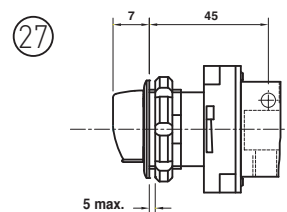

Tlačítko – G1/8 ventily

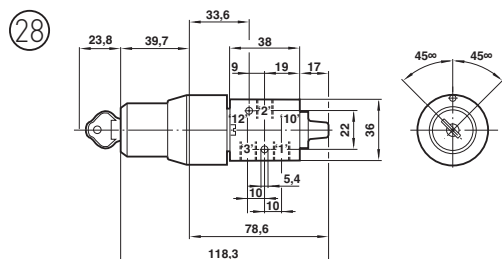

Pedál/šlapadlo – G1/8-G1/4 ventily

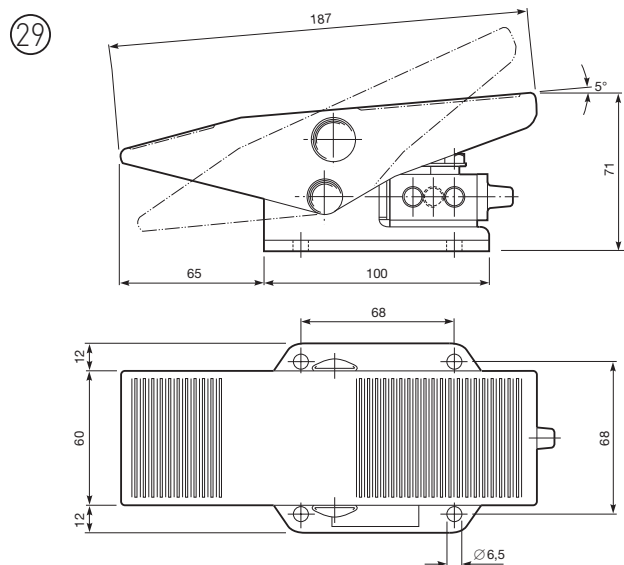

Páka – G1/8 ventily

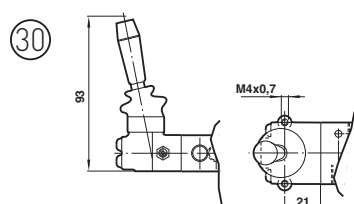

Páka – G1/4 ventily

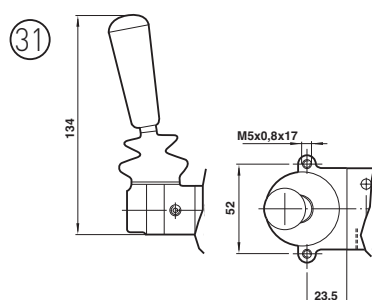

Páka/pružina/páka – G1/4 ventily

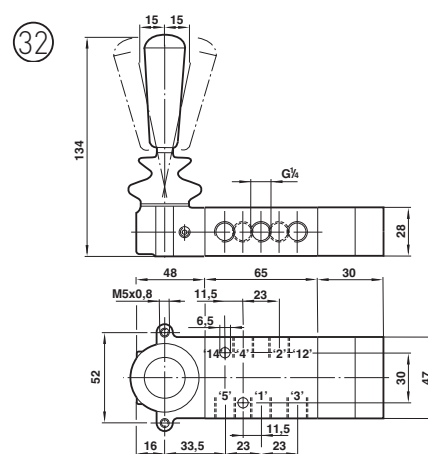

Ovládací síla: 12 N (X3 3638 02 a X3 3678 02),

15 N (X3 3637 02 a X3 3677 02)

Otvor v panelu: Ø 31 mm

Tloušťka panelu: Maximálně 8 mm