

# ROTARY VANE ACTUATORS

## M/60280

Double acting – 30° ... 270° rotation angles



M/60280/1/2/3/4

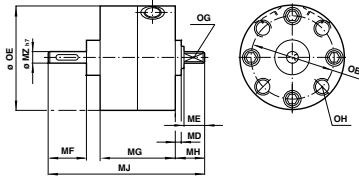

M/60285/6/7/8

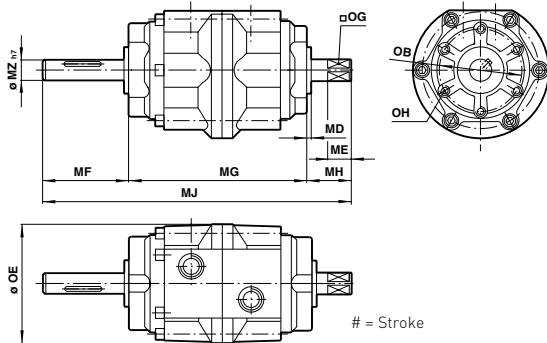

### Dimensions

Model	MD	ME	MF	MG	MJ	MH	Ø MZ7	Ø OB	Ø OE	OG-0,1	OH	Keway
M/60280	2	6	13	20	46	10	4	26	29	Ø4 h7	M3 x 6	-
M/60281	2	7	15	26	55	10	5	30	36,5	Ø5 h7	M3 x 6	-
M/60282	2	7	18	40	73	10	6	35	42,5	Ø6 h7	M3 x 6	-
M/60283	2	7	23	55	93,5	10	8	40	49,5	6	M5 x 8	3-0,03; 2+0,1*
M/60284	2,5	10	26	60	105	13,5	10	56	64	8	M5 x 8	4-0,03; 2,5+0,1*
M/60285	2,5	13	39,5	86	145	19,5	12	45	79	10	M6 x 9	4-0,03; 2,5+0,1*
M/60286	3	16	53,5	103	180	23,5	17	70	110	13	M8 x 12	5-0,03; 3+0,1*
M/60287	3,5	22	65	125	220	30	25	80	141,5	19	M10 x 15	7-0,038; 4+0,2*
M/60288	4,5	35	69,5	171	285	44,5	40	120	196	32	M12 x 18	12-0,043; 5+0,2*

### Models

MODELS WITH FIXED OR ADJUSTABLE ROTATION ANGLES					
Model	Angle of rotation/ Adjustment	Output shaft Ø	Port	Number of vanes	Torque at 6 bar (Nm)

### Accessories

Banjo flow control	Straight fitting	Elbow Fitting	Service kit
--------------------------	---------------------	------------------	----------------



M/60280/90	90°	4	M5	Single	0,15	COK510405	C02250405	C02470405	QM/60280/00
M/60280/180	180°	4	M5	Single	0,15	COK510405	C02250405	C02470405	QM/60280/00
M/60281/90	90°	5	M5	Single	0,38	COK510405	C02250405	C02470405	QM/60281/00
M/60281/180	180°	5	M5	Single	0,38	COK510405	C02250405	C02470405	QM/60281/00
M/60281/IE	30 to 180°	5	M5	Single	0,38	COK510405	C02250405	C02470405	QM/60281/00
M/60282/90	90°	6	M5	Single	1,20	COK510405	C02250405	C02470405	QM/60282/00
M/60282/180	180°	6	M5	Single	1,20	COK510405	C02250405	C02470405	QM/60282/00
M/60282/IE	30 to 180°	6	M5	Single	1,20	COK510405	C02250405	C02470405	QM/60282/00

If you can't see the option you require...

...call the Express hotline now!











For further information  
www.norgren.com/info/nec/en049



## ROTARY VANE ACTUATORS M/60280

Double acting – 30° ... 270° rotation angles

### Models

MODELS WITH FIXED OR ADJUSTABLE ROTATION ANGLES						Accessories			
Model	Angle of rotation/ Adjustment	Output shaft Ø	Port	Number of vanes	Torque at 6 bar (Nm)	Banjo flow control	Straight fitting	Elbow Fitting	Service kit
									
M/60283/90	90°	8	M5	Single	2,10	C0K510405	C02250405	C02470405	QM/60283/00
M/60283/180	180°	8	M5	Single	2,10	C0K510405	C02250405	C02470405	QM/60283/00
M/60283/IE	30 ... 180°	8	M5	Single	2,10	C0K510405	C02250405	C02470405	QM/60283/00
M/60284/90	90°	10	G1/8	Single	4,10	C0K510618	C02250618	C02470618	QM/60284/00
M/60284/TI/90	90°	10	G1/8	Double	9,50	C0K510618	C02250618	C02470618	QM/60284/TI/00
M/60284/180	180°	10	G1/8	Single	4,10	C0K510618	C02250618	C02470618	QM/60284/00
M/60284/270	270°	10	G1/8	Single	4,10	C0K510618	C02250618	C02470618	QM/60284/00
M/60284/IE	30 ... 270°	10	G1/8	Single	4,10	C0K510618	C02250618	C02470618	QM/60284/00
M/60284/TE	30 ... 90°	10	G1/8	Double	9,50	C0K510618	C02250618	C02470618	QM/60284/TI/00
									
M/60285/90	90°	12	G1/8	Single	5,80	C0K510618	C02250618	C02470618	QM/60285/00
M/60285/TI/90	90°	12	G1/8	Double	12,80	C0K510618	C02250618	C02470618	QM/60285/TI/00
M/60285/180	180°	12	G1/8	Single	5,80	C0K510618	C02250618	C02470618	QM/60285/00
M/60285/270	270°	12	G1/8	Single	5,80	C0K510618	C02250618	C02470618	QM/60285/00
M/60286/90	90°	17	G1/4	Single	18,00	C0K510628	C02250628	C02470628	QM/60286/00
M/60286/TI/90	90°	17	G1/4	Double	41,50	C0K510628	C02250628	C02470628	QM/60286/TI/00
M/60286/180	180°	17	G1/4	Single	18,00	C0K510628	C02250628	C02470628	QM/60286/00
M/60286/270	270°	17	G1/4	Single	18,00	C0K510628	C02250628	C02470628	QM/60286/00
M/60287/90	90°	25	G3/8	Single	34,50	C0K510838	C02250838	C02470838	QM/60287/00
M/60287/TI/90	90°	25	G3/8	Double	83,00	C0K510838	C02250838	C02470838	QM/60287/TI/00
M/60287/180	180°	25	G3/8	Single	34,50	C0K510838	C02250838	C02470838	QM/60287/00
M/60287/270	270°	25	G3/8	Single	34,50	C0K510838	C02250838	C02470838	QM/60287/00
M/60288/90	90°	40	G1/2	Single	123,00	C0K510848	C02250848	C02470848	QM/60288/00
M/60288/TI/90	90°	40	G1/2	Double	247,00	C0K510848	C02250848	C02470848	QM/60288/TI/00
M/60288/180	180°	40	G1/2	Double	123,00	C0K510848	C02250848	C02470848	QM/60288/00
M/60288/270	270°	40	G1/2	Single	123,00	C0K510848	C02250848	C02470848	QM/60288/00

### MOUNTINGS FOR M/60280 Rotary vane actuators

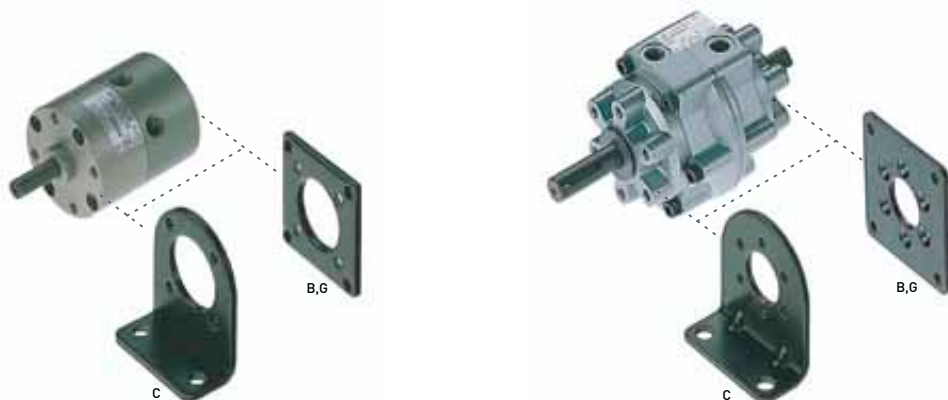

Model	B, G	C	Model	B, G	C
M/60280	QM/60280/22	QM/60280/21	M/60285	QM/60285/22	QM/60285/21
M/60281	QM/60281/22	QM/60281/21	M/60286	QM/60286/22	QM/60286/21
M/60282	QM/60282/22	QM/60282/21	M/60287	-	QM/60287/21
M/60283	QM/60283/22	QM/60283/21	M/60288	-	QM/60288/21
M/60284	QM/60284/22	QM/60284/21			

If you can't see the option you require...  
...call the Express hotline now!